



SEMLIGHT SEMICONDUCTOR LIGHTING CO., LIMITED

CE EMC REPORT

Prepared For :	SEMLIGHT SEMICONDUCTOR LIGHTING CO., LIMITED 5F, Building No.2, Yituan Industrial Park,10th Shangxue Yituan Road, Bantian Street, Longgang District, Shenzhen
Product Name:	LED EXPLOSION PROOF LIGHT
Trade Name:	SEMLIGHT
Model :	SEM-EX100-A, SEM-EX20-A, SEM-EX20-B, SEM-EX30-A, SEM-EX30-B, SEM-EX40-A, SEM-EX40-B, SEM-EX50-A, SEM-EX50-B, SEM-EX60-A, SEM-EX60-B, SEM-EX60-C, SEM-EX70-A, SEM-EX70-B, SEM-EX80-A, SEM-EX80-B, SEM-EX90-A, SEM-EX90-B, SEM-EX90-C, SEM-EX100-B, SEM-EX110-A, SEM-EX110-B, SEM-EX120-A, SEM-EX120-B, SEM-EX120-C, SEM-EX150-B, SEM-EX160-C, SEM-EX180-C, SEM-EX200-C, SEM-EX240-C, SEM-EX300-C, SEM-EX360-C
Prepared By :	Shenzhen BST Technology Co., Ltd. Building No.23-24, Zhiheng Industrial Park, Guankouer Road, Nantou,Nanshan District,Shenzhen,Guangdong,China
Test Date:	May. 20-21 , 2013
Date of Report :	May. 21 , 2013
Report No.:	BSTDG13050802ER-1



TABLE OF CONTENTS

TEST REPORT DECLARATION	5
1. TEST RESULTS SUMMARY	6
2. GENERAL INFORMATION	7
2.1. Report information	7
2.2. Measurement Uncertainty	7
3. PRODUCT DESCRIPTION	8
3.1. EUT Description.....	8
3.2. Block Diagram of EUT Configuration	8
3.3. Operating Condition of EUT	8
3.4. Test Conditions.....	8
3.5. Modifications.....	8
3.6. Abbreviations	9
3.7. Performance Criterion	9
4. TEST EQUIPMENT USED	10
4.1. For Conducted Emission Test	10
4.2. For Magnetic Test (In Shielding Room)	10
4.3. For Radiated Emission Measurement.....	10
4.4. For Harmonic / Flicker Test	10
4.5. For Electrostatic Discharge Immunity Test.....	10
4.6. For RF Strength Susceptibility Test	11
4.7. For Electrical Fast Transient/Burst Immunity Test	11
4.8. For Surge Test	11
4.9. For Injected Currents Susceptibility Test.....	11
4.10. For Magnetic Field Immunity Test.....	11
4.11. For Voltage Dips and Interruptions Test	11
5. POWER LINE CONDUCTED EMISSION TEST	12
5.1. Block Diagram of Test Setup	12
5.2. Test Standard.....	12
5.3. Power Line Conducted Emission Limit	12
5.4. EUT Configuration on Test.....	12
5.5. Operating Condition of EUT	13
5.6. Test Procedure	13
5.7. Test Result.....	13
6. MAGNETIC TEST	14
6.1. Block Diagram of Test Setup	14
6.2. Test Standard.....	14
6.3. Magnetic Field Emission Limits	14
6.4. EUT Configuration on Test.....	14
6.5. Operating Condition of EUT	14
6.6. Test Procedure	15
6.7. Test Results	15
7. RADIATED EMISSION TEST	16
7.1. Open Site Setup Diagram	16
7.2. Test Standard.....	16
7.3. Radiated Emission Limit	16



7.4.	EUT Configuration on Test	16
7.5.	Operating Condition of EUT	17
7.6.	Test Procedure	17
7.7.	Test Results	17
8.	HARMONIC CURRENT EMISSION TEST	18
8.1.	Block Diagram of Test Setup	18
8.2.	Test Standard.....	18
8.3.	Operating Condition of EUT	18
8.4.	Test Procedure	18
8.5.	Test Results	18
9.	VOLTAGE FLUCTUATIONS & FLICKER TEST.....	19
9.1.	Block Diagram of Test Setup	19
9.2.	Test Standard.....	19
9.3.	Operating Condition of EUT	19
9.4.	Test Data.....	19
9.5.	Test Results	19
10.	ELECTROSTATIC DISCHARGE TEST.....	20
10.1.	Block Diagram of ESD Test Setup.....	20
10.2.	Test Standard.....	20
10.3.	Severity Levels and Performance Criterion.....	20
10.4.	EUT Configuration on Test.....	20
10.5.	Operating Condition of EUT	21
10.6.	Test Procedure	21
10.7.	Test Results	21
11.	RF FIELD STRENGTH SUSCEPTIBILITY TEST.....	23
11.1.	R/S Test Setup	23
11.2.	Test Standard.....	23
11.3.	Severity Levels and Performance Criterion.....	23
11.4.	EUT Configuration on Test.....	24
11.5.	Operating Condition of EUT	24
11.6.	Test Procedure	24
11.7.	Test Results	24
12.	ELECTRICAL FAST TRANSIENT/BURST TEST.....	26
12.1.	EFT Test Setup	26
12.2.	Test Standard.....	26
12.3.	Severity Levels and Performance Criterion.....	26
12.4.	EUT Configuration on Test.....	26
12.5.	Operating Condition of EUT	26
12.6.	Test Procedure	27
12.7.	Test Results	27
13.	SURGE TEST.....	29
13.1.	Surge Test Setup.....	29
13.2.	Test Standard.....	29
13.3.	Severity Levels and Performance Criterion.....	29
13.4.	EUT Configuration on Test.....	29
13.5.	Operating Condition of EUT	29
13.6.	Test Procedure	30
13.7.	Test Results	30



14. INJECTED CURRENTS SUSCEPTIBILITY TEST	32
14.1. Block Diagram of Test AC Mains Setup.....	32
14.2. Test Standard.....	32
14.3. Severity Levels and Performance Criterion.....	32
14.4. EUT Configuration on Test.....	32
14.5. Operating Condition of EUT	32
14.6. Test Procedure	33
14.7. Test Results	33
15. MAGNETIC FIELD IMMUNITY TEST.....	35
15.1. Block Diagram of Test Setup	35
15.2. Test Standard.....	35
15.3. Severity Levels and Performance Criterion.....	35
15.4. EUT Configuration on Test.....	35
15.5. Operating Condition of EUT	36
15.6. Test Procedure	36
15.7. Test Results	36
16. VOLTAGE DIPS AND INTERRUPTIONS TEST	38
16.1. Voltage Dips and Interruptions Test Setup	38
16.2. Test Standard.....	38
16.3. Severity Levels and Performance Criterion.....	38
16.4. EUT Configuration on Test.....	38
16.5. Operating Condition of EUT	38
16.6. Test Procedure	39
16.7. Test Result.....	39
APPENDIX I	41
APPENDIX II.....	46
APPENDIX III	50
APPENDIX IV	53



TEST REPORT DECLARATION

Applicant	:	SEMLIGHT SEMICONDUCTOR LIGHTING CO., LIMITED
Address	:	5F, Building No.2, Yituan Industrial Park,10th Shangxue Yituan Road, Bantian Street, Longgang District, Shenzhen
EUT Description	:	LED EXPLOSION PROOF LIGHT
Trade Name	:	SEMLIGHT
Model Number	:	SEM-EX100-A, SEM-EX20-A, SEM-EX20-B, SEM-EX30-A, SEM-EX30-B, SEM-EX40-A, SEM-EX40-B, SEM-EX50-A, SEM-EX50-B, SEM-EX60-A, SEM-EX60-B, SEM-EX60-C, SEM-EX70-A, SEM-EX70-B, SEM-EX80-A, SEM-EX80-B, SEM-EX90-A, SEM-EX90-B, SEM-EX90-C, SEM-EX100-B, SEM-EX110-A, SEM-EX110-B, SEM-EX120-A, SEM-EX120-B, SEM-EX120-C, SEM-EX150-B, SEM-EX160-C, SEM-EX180-C, SEM-EX200-C, SEM-EX240-C, SEM-EX300-C, SEM-EX360-C

Test Standards:

- EN 55015:2006+A1:2007+A2:2009
- EN 61547:2009
- EN 61000-3-2:2006+A1:2009+A2:2009
- EN 61000-3-3:2008(EN 61000-4-2:2009, EN 61000-4-3:2006+A1:2008+A2:2010, EN 61000-4-4:2012, EN 61000-4-5:2006, EN 61000-4-6:2009, EN 61000-4-8:2010, EN 61000-4-11:2004)

The EUT described above is tested by BST Technology Co., Ltd. EMC Laboratory to determine the maximum emissions from the EUT and ensure the EUT to be compliance with the immunity requirements of the EUT. BST Technology Co., Ltd. EMC Laboratory is assumed full responsibility for the accuracy of the test results. Also, this report shows that the EUT technically complies with the 2004/108/EC directive and its amendment requirements.

The test report is valid for above tested sample only and shall not be reproduced in part without written approval of the laboratory.

Prepared by :

Grace

Assistant

Tested by:

Jane.zhu

Test Engineer

Reviewer :

Diana

Supervisor

Approved & Authorized Signer :

Christina

Christina / Manager



1. TEST RESULTS SUMMARY

Table 1 Test Results Summary

Test Items	Test Results
Power Line Conducted Emission Test	PASS
Magnetic Test	PASS
Radiated Emission	PASS
Harmonic Current Emission Test	PASS
Voltage Fluctuations & Flicker Test	PASS
Electrostatic Discharge Test	PASS
RF Field Strength Susceptibility Test	PASS
Electrical Fast Transient/Burst Test	PASS
Surge Test	PASS
Injected Currents Susceptibility Test	PASS
Magnetic Field Immunity Test	PASS
Voltage Dips And Interruptions Test	PASS



2. GENERAL INFORMATION

2.1. Report information

- 2.1.1. This report is not a certificate of quality; it only applies to the sample of the specific product/equipment given at the time of its testing. The results are not used to indicate or imply that they are application to the similar items. In addition, such results must not be used to indicate or imply that BST approves recommends or endorses the manufacture, supplier or use of such product/equipment, or that BST in any way guarantees the later performance of the product/equipment.
- 2.1.2. The sample/s mentioned in this report is/are supplied by Applicant, BST therefore assumes no responsibility for the accuracy of information on the brand name, model number, origin of manufacture or any information supplied.
- 2.1.3. Additional copies of the report are available to the Applicant at an additional fee. No third part can obtain a copy of this report through BST, unless the applicant has authorized BST in writing to do so.

2.2. Measurement Uncertainty

Available upon request.



3. PRODUCT DESCRIPTION

3.1. EUT Description

Description	:	LED EXPLOSION PROOF LIGHT
Applicant	:	SEMLIGHT SEMICONDUCTOR LIGHTING CO., LIMITED 5F, Building No.2, Yituan Industrial Park, 10th Shangxue Yituan Road, Bantian Street, Longgang District, Shenzhen
Manufacturer	:	SEMLIGHT SEMICONDUCTOR LIGHTING CO., LIMITED 5F, Building No.2, Yituan Industrial Park, 10th Shangxue Yituan Road, Bantian Street, Longgang District, Shenzhen
Model Number	:	SEM-EX100-A, SEM-EX20-A, SEM-EX20-B, SEM-EX30-A, SEM-EX30-B, SEM-EX40-A, SEM-EX40-B, SEM-EX50-A, SEM-EX50-B, SEM-EX60-A, SEM-EX60-B, SEM-EX60-C, SEM-EX70-A, SEM-EX70-B, SEM-EX80-A, SEM-EX80-B, SEM-EX90-A, SEM-EX90-B, SEM-EX90-C, SEM-EX100-B, SEM-EX110-A, SEM-EX110-B, SEM-EX120-A, SEM-EX120-B, SEM-EX120-C, SEM-EX150-B, SEM-EX160-C, SEM-EX180-C, SEM-EX200-C, SEM-EX240-C, SEM-EX300-C, SEM-EX360-C

3.2. Block Diagram of EUT Configuration

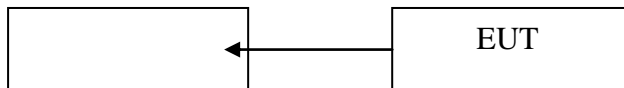

3.3. Operating Condition of EUT

Test mode 1: ON

3.4. Test Conditions

Temperature: 23-26°C

Relative Humidity: 55-68 %

3.5. Modifications

No modification was made.



3.6. Abbreviations

AC	Alternating Current
AMN	Artificial Mains Network
DC	Direct Current
EM	ElectroMagnetic
EMC	ElectroMagnetic Compatibility
EUT	Equipment Under Test
IF	Intermediate Frequency
RF	Radio Frequency
rms	root mean square
EMI	Electromagnetic Interference
EMS	Electromagnetic Susceptibility

3.7. Performance Criterion

Criterion A: The equipment shall continue to operate as intended without operator intervention. No degradation of performance or loss of function is allowed below a performance level specified by the manufacturer when the equipment is used as intended.

Criterion B: After the test, the equipment shall continue to operate as intended without operator intervention. No degradation of performance or loss of function is allowed, after the application of the phenomena below a performance level specified by the manufacturer, when the equipment is used as intended.

Criterion C: Loss of function is allowed, provided the function is self-recoverable, or can be restored by the operation of the controls by the user in accordance with the manufacturer's instructions.



4. TEST EQUIPMENT USED

4.1. For Conducted Emission Test

Item	Equipment	Manufacturer	Model No.	Serial No.	Last Cal.	Cal. Interval
1.	Test Receiver	Rohde & Schwarz	ESHS30	828985/018	Jun 01,12	1 Year
2.	Pulse Limiter	Rohde & Schwarz	ESH3-Z2	100006	Jun 01,12	1 Year
3.	L.I.S.N.	Rohde & Schwarz	ESH2-Z5	834549/005	Jun 01,12	1 Year
4.	Conical	Emtek	N/A	N/A	N/A	N/A
5.	Voltage Probe	Schwarzbeck	TK9416	N/A	Jun. 01. 12	1 Year
6.	Coaxial Switch	Anritsu	MP59B	6100214550	Jun 01,12	1 Year

4.2. For Magnetic Test (In Shielding Room)

Item	Equipment	Manufacturer	Model No.	Serial No.	Last Cal.	Cal. Interval
1.	Test Receiver	Rohde & Schwarz	ESHS20	836600/006	Jun. 04, 12	1 Year
2.	Triple-loop Antenna	Rohde & Schwarz	HM020	843885/002	Jun. 05, 12	1 Year
3.	RF Cable	MIYAZAKI	5D-2W	Tri-loop Cable	Jun. 28, 12	1/2 Year
4.	Coaxial Switch	Anritsu	MP59B	M73989	Jun. 04, 12	1/2 Year

4.3. For Radiated Emission Measurement

Item	Equipment	Manufacturer	Model No.	Serial No.	Last Cal.	Cal. Interval
1.	Spectrum Analyzer	ANRITSU	MS2661C	6200140915	Jun 01, 12	1 Year
2.	Test Receiver	Rohde&Schwarz	ESC830	828982/018	Jun 01, 12	1 Year
3.	Bilog Antenna	Schwarzbeck	VULB9163	142	Jun 01,12	1 Year
4.	50 Coaxial Switch	Anritsu Corp	MP59B	6100237248	Jun 01,12	1 Year
5.	Cable	Schwarzbeck	AK9513	ACRX1	Jun 01,12	1 Year
6.	Cable	Rosenberger	N/A	FR2RX2	Jun 01,12	1 Year
7.	Cable	Schwarzbeck	AK9513	CRRX2	Jun 01,12	1 Year
8.	Cable	Schwarzbeck	AK9513	CRRX2	Jun 01,12	1 Year
9.	Signal Generator	HP	864A	3625U00573	Jun 01,12	1 Year

4.4. For Harmonic / Flicker Test

Item	Equipment	Manufacturer	Model No.	Serial No.	Last Cal.	Cal. Interval
1.	Harmonic and Flicker analyzer	Laplace	AC2000A	309709	Oct. 15, 2012	1 Year

4.5. For Electrostatic Discharge Immunity Test

Item	Equipment	Manufacturer	Model No.	Serial No.	Last Cal.	Cal. Interval
1.	ESD Tester	HAEFELY	PSD 1600	H911'292	Jun. 02, 12	1 Year



4.6. For RF Strength Susceptibility Test

Item	Equipment	Manufacturer	Model No.	Serial No.	Last Cal.	Cal. Interval
1.	Signal Generator	HP	8648A	3633A02081	Jun. 03, 12	1 Year
2.	Amplifier	A&R	500A100	17034	NCR	NCR
3.	Amplifier	A&R	100W/1000M1	17028	NCR	NCR
4.	Isotropic Field Monitor	A&R	FM2000	16829	NCR	NCR
5.	Isotropic Field Probe	A&R	FLW220100	16755	Jun. 03, 12	1 Year
6.	Biconic Antenna	EMCO	3108	9507-2534	NCR	NCR
7.	Log-periodic Antenna	A&R	AT1080	16812	NCR	NCR
8.	PC	N/A	486DX2	N/A	N/A	N/A

4.7. For Electrical Fast Transient/Burst Immunity Test

Item	Equipment	Manufacturer	Model No.	Serial No.	Last Cal.	Cal. Interval
1.	Burst Tester	HAEFELY	PEFT 4010	080981-16	Jun 01,12	1 Year

4.8. For Surge Test

Item	Equipment	Manufacturer	Model No.	Serial No.	Last Cal.	Cal. Interval
1.	Surge Tester	HAEFELY	PSURGE4.1	080107-04	Jun 01,12	1 Year

4.9. For Injected Currents Susceptibility Test

Item	Equipment	Manufacturer	Model No.	Serial No.	Last Cal.	Cal. Interval
1.	Simulator	EMTEST	CWS 500C	0900-12	Jun 01,12	1 Year
2.	CDN	EMTEST	CDN-M2	510010010010	Jun 01,12	1 Year
3.	VDN	EMTEST	CDN-M3	0900-11	Jun 01,12	1 Year
4.	Injection Clamp	EMTEST	F-2031-23MM	368	Jun 01,12	1 Year
5.	Attenuator	EMTEST	ATT6	0010222a	Jun 01,12	1 Year

4.10. For Magnetic Field Immunity Test

Item	Equipment	Manufacturer	Model No.	Serial No.	Last Cal.	Cal. Interval
1.	Magnetic Field Tester	HEAFELY	MAG100.1	083858-10	Jun 01,12	1 Year

4.11. For Voltage Dips and Interruptions Test

Item	Equipment	Manufacturer	Model No.	Serial No.	Last Cal.	Cal. Interval
2.	Dips Tester	HEAFELY	PLINE 1610	083732-18	Jun 01,12	1 Year



5. POWER LINE CONDUCTED EMISSION TEST

5.1. Block Diagram of Test Setup

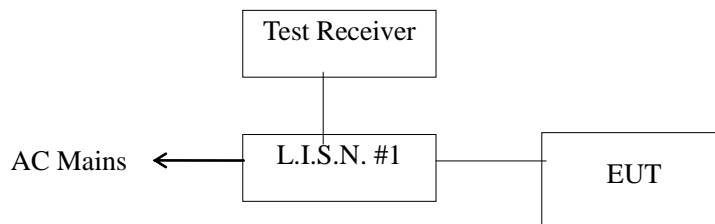

5.2. Test Standard

EN 55015:2006+A1:2007+A2:2009

5.3. Power Line Conducted Emission Limit

Frequency	At mains terminals (dB μ V)	
	Quasi-peak Level	Average Level
9KHz ~ 50KHz	110	--
50KHz ~ 150KHz	90 ~ 80*	--
150KHz ~ 0.5MHz	66 ~ 56*	56 ~ 46*
0.5MHz ~ 5.0MHz	56	46
5.0MHz ~ 30MHz	60	50

1. At the transition frequency the lower limit applies.
2. * decreasing linearly with logarithm of the frequency.

5.4. EUT Configuration on Test

The following equipments are installed on conducted emission test to meet EN55015 requirement and operating in a manner, which tends to maximize its emission characteristics in a normal application.

5.4.1. EUT Information

Model Number : SEM-EX100-A
Serial Number : N/A
Manufacturer : SEMLIGHT SEMICONDUCTOR LIGHTING CO., LIMITED



5.5. Operating Condition of EUT

- 5.5.1. Setup the EUT and simulators as shown in Section 5.4
- 5.5.2. Turn on the power of all equipments.
- 5.5.3. Let the EUT work in test modes (ON) and test it.

5.6. Test Procedure

The EUT is put on the table which is 0.8 meter high above the ground and connected to the AC mains through a Line Impedance Stabilization Network (L.I.S.N.). This provided a 50ohm coupling impedance for the tested equipments. Both sides of AC line are checked to find out the maximum conducted emission according to the EN55015 regulations during conducted emission test. And the voltage probe had been used for the load terminals test according to the EN55015 standard.

The bandwidth of the test receiver (R&S ESHS20) is set at 10KHz. in 150KHz~30MHz and 200Hz bandwidth in 9KHz~150KHz.

The frequency range from 9KHz to 30MHz is checked.

All the test results are listed in Section 5.7. The scanning waveform is put in **Appendix I**.

5.7. Test Result

PASS.

6. MAGNETIC TEST

6.1. Block Diagram of Test Setup

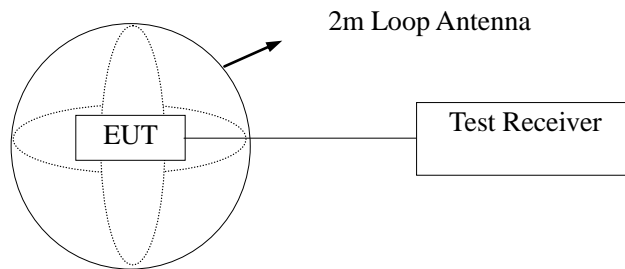

(EUT: LED EXPLOSION PROOF LIGHT)

6.2. Test Standard

EN 55015:2006+A1:2007+A2:2009

6.3. Magnetic Field Emission Limits

Frequency	Limits for loop diameter (dB μ A)
	2m
9KHz ~ 70KHz	88
70KHz ~ 150KHz	88 ~ 58*
150KHz ~ 2.2MHz	58 ~ 26*
2.2MHz ~ 3.0MHz	58
3.0MHz ~ 30MHz	22

1. At the transition frequency the lower limit applies.
2. * decreasing linearly with logarithm of the frequency.

6.4. EUT Configuration on Test

The configuration of the EUT is same as Section 5.4

6.5. Operating Condition of EUT

- 6.5.1. Setup the EUT as shown in Section 6.1.
- 6.5.2. Turn on the power of all equipments.
- 6.5.3. Let the EUT work in test mode (ON) and test it.



6.6. Test Procedure

The EUT is placed on a wood table in the center of a loop antenna. The induced current in the loop antenna is measured by means of a current probe and the test receiver. Three field components is checked by means of a coax switch.

The frequency range from 9KHz to 30MHz is investigated. The receiver is measured with the quasi-peak detector. For frequency band 9KHz to 150KHz, the bandwidth of the field strength meter (R&S test receiver ESHS20) is set at 200Hz. For frequency band 150KHz to 30MHz, the bandwidth is set at 10KHz.

All the test results are listed in Section 6.7. and all the scanning waveform is put in **Appendix II**.

6.7. Test Results

PASS.

The frequency range from 9KHz to 30MHz is investigated.
As the peak value is too low against the limit, so the Quasi-peak value has been omitted.



7. RADIATED EMISSION TEST

7.1. Open Site Setup Diagram

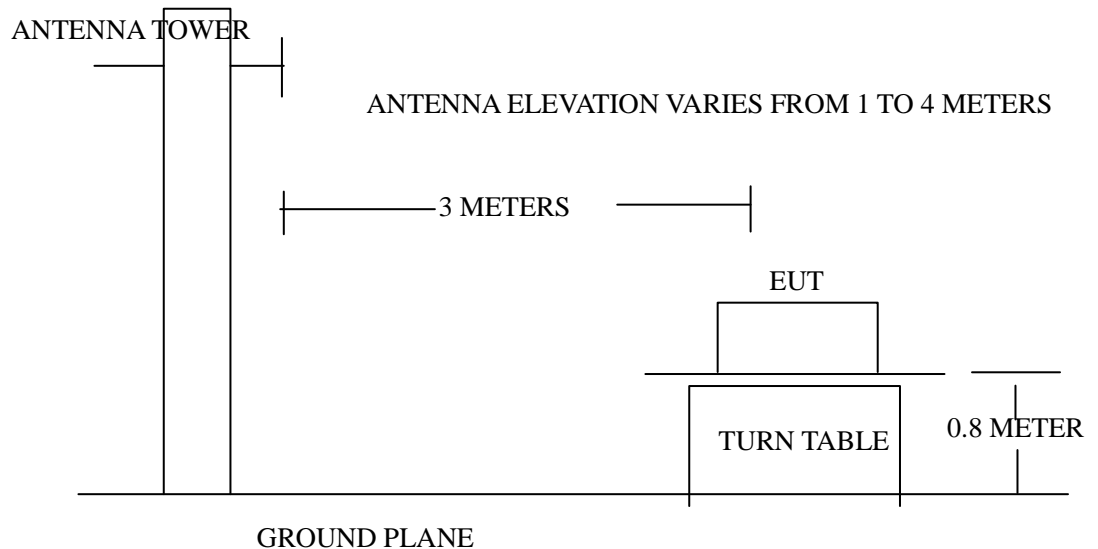

7.2. Test Standard

EN 55015:2006+A1:2007+A2:2009

7.3. Radiated Emission Limit

All emanations from a computing devices or system, including any network of conductors and apparatus connected thereto, shall not exceed the level of field strengths specified below:

FREQUENCY (MHz)	DISTANCE (Meters)	FIELD STRENGTHS LIMITS (dB μ V/m)
30 ~ 230	3	40
230 ~ 300	3	47

Note:(1) The tighter limit shall apply at the edge between two frequency bands.

(2) Distance refers to the distance in meters between the measuring instruments antenna and the closed point of any part of the EUT.

7.4. EUT Configuration on Test

The EN55015 regulations test method must be used to find the maximum emission during radiated emission test.



7.5. Operating Condition of EUT

- 7.5.1. Setup the EUT as shown on Section 7.1
- 7.5.2. Turn on the power of all equipments.
- 7.5.3. Let the EUT work in test mode and measure it.

7.6. Test Procedure

The EUT is placed on a turn table which is 0.8 meter above ground. The turn table can rotate 360 degrees to determine the position of the maximum emission level. The EUT is set 3 meters away from the receiving antenna which is mounted on an antenna tower. The antenna can move up and down between 1 to 4 meters to find out the maximum emission level. Broadband antenna (calibrated by dipole antenna) are used as a receiving antenna. Both horizontal and vertical polarization of the antenna are set on test. The bandwidth setting on the test receiver (R&S TEST RECEIVER ESCS20) is 120 KHz. The EUT is tested in Semi-Anechoic Chamber, and all the scanning waveform is put in **Appendix III.**

7.7. Test Results

PASS.



8. HARMONIC CURRENT EMISSION TEST

8.1. Block Diagram of Test Setup

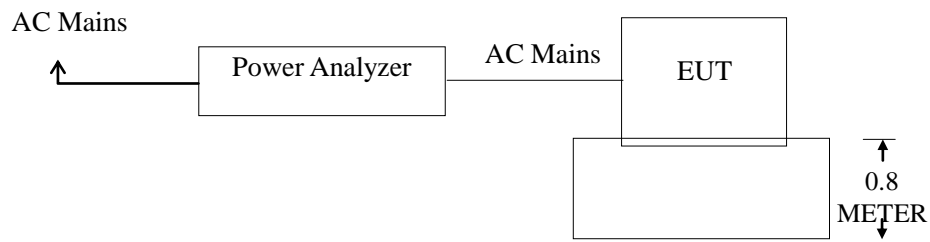

(EUT: LED EXPLOSION PROOF LIGHT)

8.2. Test Standard

EN 61000-3-2:2006+A1:2009+A2:2009

Class A

8.3. Operating Condition of EUT

- 8.3.1. Setup the EUT as shown in Section 8.1
- 8.3.2. Turn on the power of all equipments.
- 8.3.3. Let the EUT work in test mode (ON) and test it.

8.4. Test Procedure

The power cord of the EUT is connected to the output of the test system. Turn on the Power of the EUT and use the test system to test the harmonic current level.

8.5. Test Results

PASS.



9. VOLTAGE FLUCTUATIONS & FLICKER TEST

9.1. Block Diagram of Test Setup

Same as Section 8.1

9.2. Test Standard

EN61000-3-3:2008

9.3. Operating Condition of EUT

Same as Section 8.3. The power cord of the EUT is connected to the output of the test system. Turn on the power of the EUT and use the test system to test the harmonic current level.

Flicker Test Limit

Test items	Limits
Pst	1.0
dc	3.3%
dmax	4.0%
dt	Not exceed 3.3% for 500ms

9.4. Test Data

Flicker test Data

Model No.: SEM-EX100-A		
Test Mode: ON		
Items	Reading	Limit
dmax	0.01	4.0%
dc	0.03	3.3%
dt	0.05	Not exceed 3.3% for 500ms
Pst	0.001	1.0

9.5. Test Results

PASS.



10. ELECTROSTATIC DISCHARGE TEST

10.1. Block Diagram of ESD Test Setup

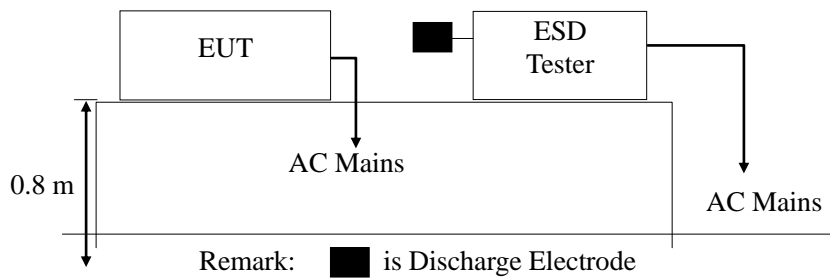

10.2. Test Standard

EN61547:2009 (EN61000-4-2:2009)
Severity Level 3 for Air Discharge at 8KV
Severity Level 2 for Contact Discharge at 4KV

10.3. Severity Levels and Performance Criterion

10.3.1. Severity level

Level	Test Voltage Contact Discharge (KV)	Test Voltage Air Discharge (KV)
1.	2	2
2.	4	4
3.	6	8
4.	8	15
X.	Special	Special

10.3.2. Performance criterion: B

10.4. EUT Configuration on Test

The configuration of EUT are listed in Section 5.4



10.5.Operating Condition of EUT

- 10.5.1.Setup the EUT as shown in Section 10.1
- 10.5.2.Turn on the power of all equipments.
- 10.5.3.Let the EUT work in test mode (ON) and test it.

10.6.Test Procedure

10.6.1.Air Discharge:

This test is done on a non-conductive surfaces. The round discharge tip of the discharge electrode shall be approached as fast as possible to touch the EUT. After each discharge, the discharge electrode shall be removed from the EUT. The generator is then re-triggered for a new single discharge and repeated 10 times for each pre-selected test point. This procedure shall be repeated until all the air discharge completed.

10.6.2.Contact Discharge:

All the procedure shall be same as Section 10.6.1. except that the tip of the discharge electrode shall touch the EUT before the discharge switch is operated.

10.6.3.Indirect discharge for horizontal coupling plane

At least 20 single discharges shall be applied to the horizontal coupling plane, at points on each side of the EUT. The discharge electrode positions vertically at a distance of 0.1m from the EUT and with the discharge electrode touching the coupling plane.

10.6.4.Indirect discharge for vertical coupling plane

At least 20 single discharge shall be applied to the center of one vertical edge of the coupling plane. The coupling plane, of dimensions 0.5m X 0.5m, is placed parallel to, and positioned at a distance of 0.1m from the EUT. Discharges shall be applied to the coupling plane, with this plane in sufficient different positions that the four faces of the EUT are completely illuminated.

10.7.Test Results

PASS.

Please refer to the following page.



Electrostatic Discharge Test Results

Shenzhen BST Technology Co., Ltd.

<i>Applicant</i> : <u>SEMLIGHT SEMICONDUCTOR LIGHTING CO., LIMITED</u>	<i>Test Date</i> : <u>May.20,2013</u>
<i>EUT</i> : <u>LED EXPLOSION PROOF LIGHT</u>	<i>Temperature</i> : <u>22 °C</u>
<i>M/N</i> : <u>SEM-EX100-A</u>	<i>Humidity</i> : <u>50 %</u>
<i>Power Supply</i> : <u>AC 230V, 50Hz</u>	<i>Test Mode</i> : <u>ON</u>

Air Discharge: ±8KV *For each point positive 10 times and negative 10 times discharge.*

Contact Discharge: ±4KV

<i>Location</i>	<i>Kind</i> A-Air Discharge C-Contact Discharge	<i>Result</i>
<i>Slots</i>	A	PASS
<i>Screw</i>	C	PASS
<i>Metal part</i>	C	PASS
<i>HCP</i>	C	PASS
<i>VCP of Front</i>	C	PASS
<i>VCP of Rear</i>	C	PASS
<i>VCP of Left</i>	C	PASS
<i>VCP of Right</i>	C	PASS

Discharge should be considered on Contact and Air and Horizontal Coupling Plane (HCP) and Vertical Coupling Plane (VCP).



11. RF FIELD STRENGTH SUSCEPTIBILITY TEST

11.1. R/S Test Setup

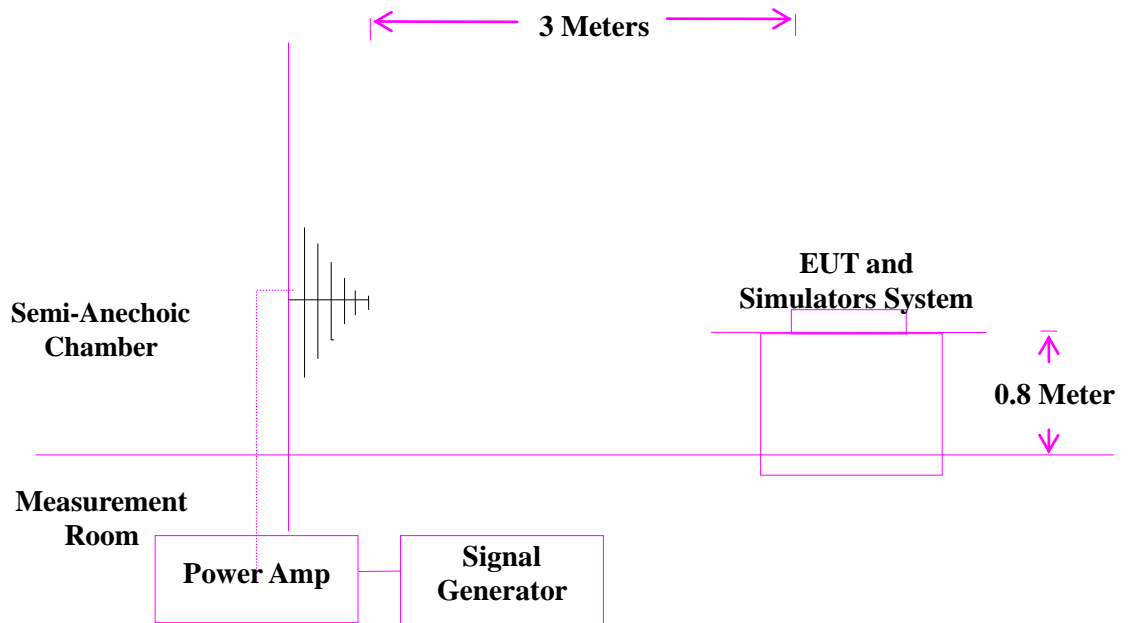

11.2. Test Standard

EN61547:2009 (EN61000-4-3:2006+A1:2008+A2:2010)
Severity Level 2 at 3V / m

11.3. Severity Levels and Performance Criterion

11.3.1. Severity level

Level	Field Strength V/m
1.	1
2.	3
3.	10
X.	Special

11.3.2. Performance criterion : A



11.4.EUT Configuration on Test

The configuration of EUT are listed in Section 5.4

11.5.Operating Condition of EUT

Setup the EUT as shown in Section 11.1.. The operating condition of EUT are listed in section 3.3.

11.6.Test Procedure

The EUT and its simulators are placed on a turn table which is 0.8 meter above the ground. The EUT is set 3 meters away from the transmitting antenna which is mounted on an antenna tower. Both horizontal and vertical polarization of the antenna are set on test. Each of the four sides of EUT must be faced this transmitting antenna and measured individually. In order to judge the EUT performance, a CCD camera is used to monitor the EUT. All the scanning conditions are as follows :

Condition of Test	Remarks
1. Fielded Strength	3 V/m (Severity Level 2)
2. Radiated Signal	Modulated
3. Scanning Frequency	80 - 1000 MHz, 1.4 - 2.7 GHz
4. Sweeping time of radiated	0.0015 decade/s
5. Dwell Time	1 Sec.

11.7.Test Results

PASS.

Please refer to the following page.



12.ELECTRICAL FAST TRANSIENT/BURST TEST

12.1.EFT Test Setup

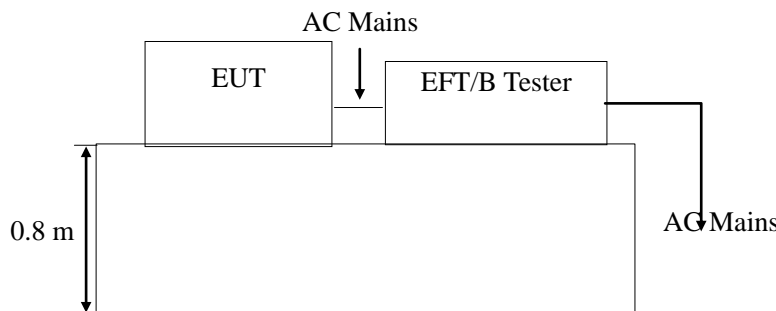

12.2.Test Standard

EN61547:2009 (EN 61000-4-4:2012)
Severity Level 2 at 1KV

12.3.Severity Levels and Performance Criterion

12.3.1.Severity level

Open Circuit Output Test Voltage $\pm 10\%$		
Level	On Power Supply Lines	On I/O (Input/Output) Signal data and control lines
1.	0.5 KV	0.25 KV
2.	1 KV	0.5 KV
3.	2 KV	1 KV
4.	4 KV	2 KV
X	Special	Special

12.3.2.Performance criterion : B

12.4.EUT Configuration on Test

The configuration of EUT are listed in Section 5.4

12.5.Operating Condition of EUT

Setup the EUT as shown in Section 12.1.. The operating condition of EUT are listed in section 3.3.



12.6. Test Procedure

The EUT is put on the table which is 0.8 meter high above the ground. This reference ground plane shall project beyond the EUT by at least 0.1m on all sides and the minimum distance between the EUT and all other conductive structure, except the ground plane beneath the EUT, shall be more than 0.5m.

12.6.1. For input and output AC power ports:

The EUT is connected to the power mains by using a coupling device which couples the EFT interference signal to AC power lines. Both polarities of the test voltage should be applied during compliance test and the duration of the test is 2 mins.

12.6.2. For signal lines and control lines ports:

It's unnecessary to test.

12.6.3. For DC output line ports:

It's unnecessary to test.

12.7. Test Results

PASS.

Please refer to the following page.



Electrical Fast Transient/Burst Test Results

Shenzhen BST Technology Co., Ltd.

<i>Applicant</i>	: <i>SEMLIGHT SEMICONDUCTOR LIGHTING CO., LIMITED</i>	<i>Test Date</i>	: <i>May.20,2013</i>						
<i>EUT</i>	: <i>LED EXPLOSION PROOF LIGHT</i>	<i>Temperature</i>	: <i>22 °C</i>						
<i>M/N</i>	: <i>SEM-EX100-A</i>	<i>Humidity</i>	: <i>50 %</i>						
<i>Power Supply</i>	: <i>AC 230V, 50Hz</i>	<i>Test Mode</i>	: <i>ON</i>						
<i>Inject Place : AC Mains</i>									
<i>Inject Line</i>	<i>Voltage KV</i>	<i>Inject Time(s)</i>	<i>Inject Method</i>	<i>Results</i>	<i>Inject Line</i>	<i>Voltage KV</i>	<i>Inject Time(s)</i>	<i>Inject Method</i>	<i>Results</i>
<i>L</i>	<i>±1</i>	<i>120</i>	<i>Direct</i>	<i>PASS</i>					
<i>N</i>	<i>±1</i>	<i>120</i>	<i>Direct</i>	<i>PASS</i>					
<i>L N</i>	<i>±1</i>	<i>120</i>	<i>Direct</i>	<i>PASS</i>					

13.SURGE TEST

13.1.Surge Test Setup

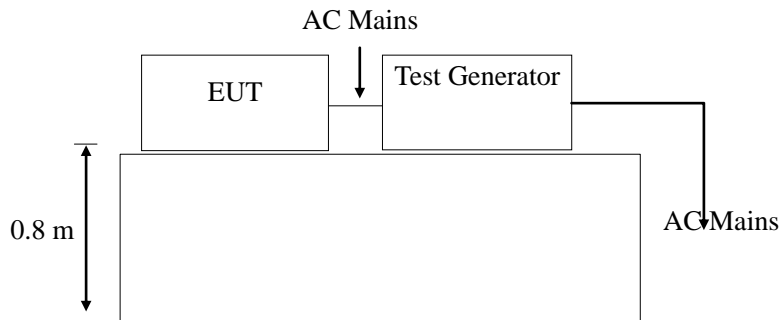

13.2.Test Standard

EN61547:2009 (EN61000-4-5:2006)
Severity Level 2 for Line to Neutral at 1.0KV

13.3.Severity Levels and Performance Criterion

13.3.1.Severity level

Severity Level	Open-Circuit Test Voltage KV
1	0.5
2	1.0
3	2.0
4	4.0
*	Special

Performance criterion : **B**

13.4.EUT Configuration on Test

The configuration of EUT are listed in Section 5.4.

13.5.Operating Condition of EUT

13.5.1.Setup the EUT as shown in Section 13.1..

13.5.2.Turn on the power of all equipments.

13.5.3.Let the EUT work in test mode (ON) and test it.



13.6.Test Procedure

- 1) Set up the EUT and test generator as shown on Section 13.1
- 2) For line to line coupling mode, provide a 0.5KV 1.2/50us voltage surge (at open-circuit condition) and 8/20us current surge to EUT selected points.
- 3) At least 5 positive and 5 negative (polarity) tests with a maximum 1/min repetition rate are conducted during test.
- 4) Different phase angles are done individually.
- 5) Record the EUT operating situation during compliance test and decide the EUT immunity criterion for above each test.

13.7.Test Results

PASS.

Please refer to the following page.



Surge Immunity Test Results

Shenzhen BST Technology Co., Ltd.

<i>Applicant</i> : <i>SEMLIGHT SEMICONDUCTOR LIGHTING CO., LIMITED</i>				<i>Test Date</i> : <i>May.20,2013</i>	
<i>EUT</i> : <i>LED EXPLOSION PROOF LIGHT</i>				<i>Temperature</i> : <i>22 °C</i>	
<i>M/N</i> : <i>SEM-EX100-A</i>				<i>Humidity</i> : <i>50 %</i>	
<i>Power Supply</i> : <i>AC 230V, 50Hz</i>				<i>Test Mode</i> : <i>ON</i>	
<i>Location</i>	<i>Polarity</i>	<i>Phase Angle</i>	<i>No of Pulse</i>	<i>Pulse Voltage (KV)</i>	<i>Result</i>
<i>L-N</i>	<i>+</i>	<i>0</i>	<i>5</i>	<i>1.0</i>	<i>PASS</i>
	<i>+</i>	<i>90</i>	<i>5</i>	<i>1.0</i>	<i>PASS</i>
	<i>+</i>	<i>180</i>	<i>5</i>	<i>1.0</i>	<i>PASS</i>
	<i>+</i>	<i>270</i>	<i>5</i>	<i>1.0</i>	<i>PASS</i>
	<i>-</i>	<i>0</i>	<i>5</i>	<i>1.0</i>	<i>PASS</i>
	<i>-</i>	<i>90</i>	<i>5</i>	<i>1.0</i>	<i>PASS</i>
	<i>-</i>	<i>180</i>	<i>5</i>	<i>1.0</i>	<i>PASS</i>
	<i>-</i>	<i>270</i>	<i>5</i>	<i>1.0</i>	<i>PASS</i>



14.INJECTED CURRENTS SUSCEPTIBILITY TEST

14.1.Block Diagram of Test AC Mains Setup

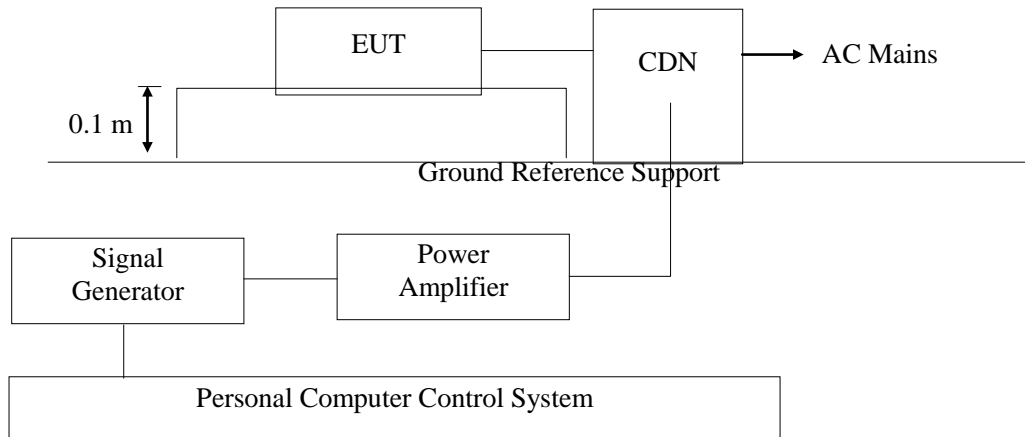

14.2.Test Standard

EN61547:2009 (EN61000-4-6:2009)
Severity Level 2 at 3 V (rms), 0.15MHz ~ 80MHz

14.3.Severity Levels and Performance Criterion

14.3.1.Severity level

Level	Field Strength V/m
1.	1
2.	3
3.	10
X	Special

14.3.2.Performance criterion: A

14.4.EUT Configuration on Test

The configuration of EUT are listed in Section 5.4

14.5.Operating Condition of EUT

Setup the EUT as shown in Section 14.1.. The operating condition of EUT are listed in section 3.3.



14.6. Test Procedure

- 1) Set up the EUT, CDN and test generators as shown on Section 14.1.
- 2) Let the EUT work in test mode and test it.
- 3) The EUT are placed on an insulating support 0.8m high above a ground reference plane. CDN (coupling and decoupling device) is placed on the ground plane about 0.3m from EUT. Cables between CDN and EUT are as short as possible, and their height above the ground reference plane shall be between 30 and 50 mm (where possible).
- 4) The disturbance signal described below is injected to EUT through CDN.
- 5) The EUT operates within its operational mode(s) under intended climatic conditions after power on.
- 6) The frequency range is swept from 150KHz to 80MHz using 3V signal level, and with the disturbance signal 80% amplitude modulated with a 1KHz sine wave.
- 7) The rate of sweep shall not exceed 1.5×10^{-3} decades/s. Where the frequency is swept incrementally, the step size shall not exceed 1% of the start and thereafter 1% of the preceding frequency value.
- 8) Recording the EUT operating situation during compliance testing and decide the EUT immunity criterion.

14.7. Test Results

PASS.

Please refer to the following page.



Injected Currents Susceptibility Test Results

Shenzhen BST Technology Co., Ltd.

<i>Applicant</i> : <i>SEMLIGHT SEMICONDUCTOR LIGHTING CO., LIMITED</i>		<i>Test Date</i> : <i>May.20,2013</i>		
<i>EUT</i> : <i>LED EXPLOSION PROOF LIGHT</i>		<i>Temperature</i> : <i>22 °C</i>		
<i>M/N</i> : <i>SEM-EX100-A</i>		<i>Humidity</i> : <i>50 %</i>		
<i>Power Supply</i> : <i>AC 230V, 50Hz</i>		<i>Test Mode</i> : <i>ON</i>		
<i>Frequency Range (MHz)</i>	<i>Injected Position</i>	<i>Strength</i>	<i>Criterion</i>	<i>Result</i>
<i>0.15 ~ 20</i>	<i>AC Line</i>	<i>3V(rms), Unmodulated</i>	<i>A</i>	<i>PASS</i>
<i>20 ~ 80</i>	<i>AC Line</i>	<i>3V(rms), Unmodulated</i>	<i>A</i>	<i>PASS</i>
<i>Remark</i> : 1. <i>Modulation Signal:1KHz 80% AM</i> 2. <i>Standard Applied : EN61000-4-6</i>		<i>Note:</i>		

15.MAGNETIC FIELD IMMUNITY TEST

15.1.Block Diagram of Test Setup

15.1.1.Block Diagram of the EUT



(EUT: LED EXPLOSION PROOF LIGHT)

15.1.2.Block Diagram of Test Setup

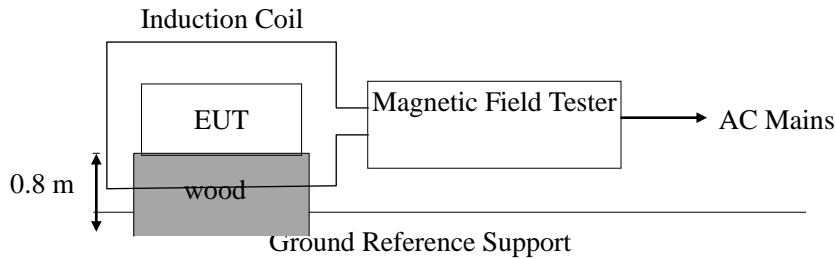

15.2.Test Standard

EN61547:2009 (EN61000-4-8:2010)

Severity Level 2 at 3A/m

15.3.Severity Levels and Performance Criterion

15.3.1.Severity level

Level	Magnetic Field Strength A/m
1.	1
2.	3
3.	10
4.	30
5.	100
X.	Special

15.3.2.Performance criterion : A

15.4.EUT Configuration on Test

The configuration of EUT are listed in Section 5.4



15.5.Operating Condition of EUT

- 15.5.1.Setup the EUT as shown in Section 15.1
- 15.5.2.Turn on the power of all equipments.
- 15.5.3.Let the EUT work in test mode (ON) and test it.

15.6.Test Procedure

The EUT shall be subjected to the test magnetic field by using the induction coil of standard dimensions (1m*1m) and shown in Section 15.1. The induction coil shall then be rotated by 90° in order to expose the EUT to the test field with different orientations.

15.7.Test Results

PASS.

Please refer to the following page.



Magnetic Field Immunity Test Results

Shenzhen BST Technology Co.,Ltd.

<i>Applicant : SEMLIGHT SEMICONDUCTOR LIGHTING CO., LIMITED</i> <i>EUT : LED EXPLOSION PROOF LIGHT</i> <i>M/N : SEM-EX100-A</i> <i>Power Supply : AC 230V, 50Hz</i>		<i>Test Date : May.20,2013</i> <i>Temperature : 22 °C</i> <i>Humidity : 60 %</i> <i>Test Engineer :</i>		
<i>Test Model: ON</i>				
<i>Test Level</i>	<i>Testing Duration</i>	<i>Coil Orientation</i>	<i>Criterion</i>	<i>Result</i>
<i>3A/M</i>	<i>5 mins</i>	<i>Horizontal</i>	<i>A</i>	<i>PASS</i>
<i>3A/M</i>	<i>5 mins</i>	<i>Vertical</i>	<i>A</i>	<i>PASS</i>
<i>Remark:</i>		<i>Test Equipment : Magnetic Field Tester MAG100.1</i>		

16. VOLTAGE DIPS AND INTERRUPTIONS TEST

16.1. Voltage Dips and Interruptions Test Setup

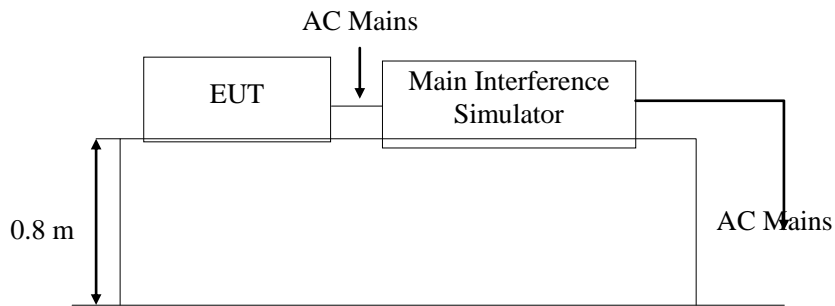

Remark: Combination wave generator and decoupling network are included in test generator.

16.2. Test Standard

EN61547:2009 (EN61000-4-11:2004)

16.3. Severity Levels and Performance Criterion

16.3.1. Severity level

Test Level %U _T	Voltage dip and short interruptions %U _T	Duration (in period)
0	100	250p
40	60	5p
70	30	0.5p

16.3.2. Performance criterion : C&B

16.4. EUT Configuration on Test

The configuration of EUT are listed in Section 5.4

16.5. Operating Condition of EUT

16.5.1. Setup the EUT as shown in Section 16.1..

16.5.2. Turn on the power of all equipments.

16.5.3. Let the EUT work in test mode (ON) and test it.



16.6.Test Procedure

- 1) Set up the EUT and test generator as shown on Section 16.1.
- 2) The interruptions is introduced at selected phase angles with specified duration.
- 3) Record any degradation of performance.

16.7.Test Result

PASS.

Please refer to the following page.



Voltage Dips And Interruptions Test Results

Shenzhen BST Technology Co., Ltd

<i>Applicant : SEMLIGHT SEMICONDUCTOR LIGHTING CO., LIMITED</i>			<i>Test Date : May.20,2013</i>		
<i>EUT : LED EXPLOSION PROOF LIGHT</i>			<i>Temperature : 22 °C</i>		
<i>M/N : SEM-EX100-A</i>			<i>Humidity : 64 %</i>		
<i>Power Supply : AC 230V, 50Hz</i>					
<i>Test Model: ON</i>					
<i>Test Level</i> <i>% U_T</i>	<i>Voltage Dips & Short Interruptions</i> <i>% U_T</i>	<i>Duration (in period)</i>	<i>Phase Angle</i>	<i>Criterion</i>	<i>Result</i>
<i>70</i>	<i>30</i>	<i>10P</i>	<i>90°</i>	<i>C</i>	<i>PASS</i>
<i>0</i>	<i>100</i>	<i>0.5P</i>	<i>180°</i>	<i>B</i>	<i>PASS</i>
<i>Remark: U_T is the rated voltage for the equipment.</i>			<i>Test Equipment : Main Interference Simulator (HEAFELY PLINE1610)</i>		



APPENDIX I

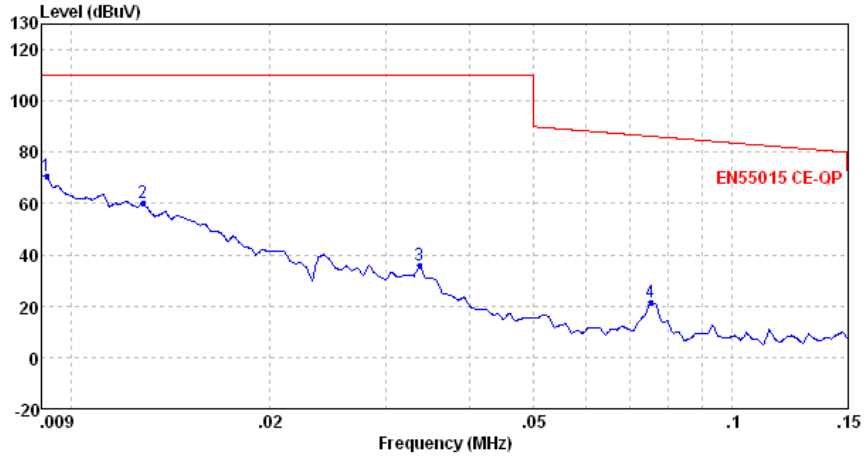

Site : Shenzhen BST Technology Co.,Ltd.

Condition:

: RBW:0.200KHz VBW:30.000KHz

	Freq	Level	Limit	Over	Remark	Pol/Phase
	MHz	dBuV	Line	Limit	dB	
1 Max	0.01	70.66	110.00	-39.34	Peak	LINE
2	0.01	60.52	110.00	-49.48	Peak	LINE
3	0.03	35.94	110.00	-74.06	Peak	LINE
4	0.08	21.61	86.27	-64.66	Peak	LINE

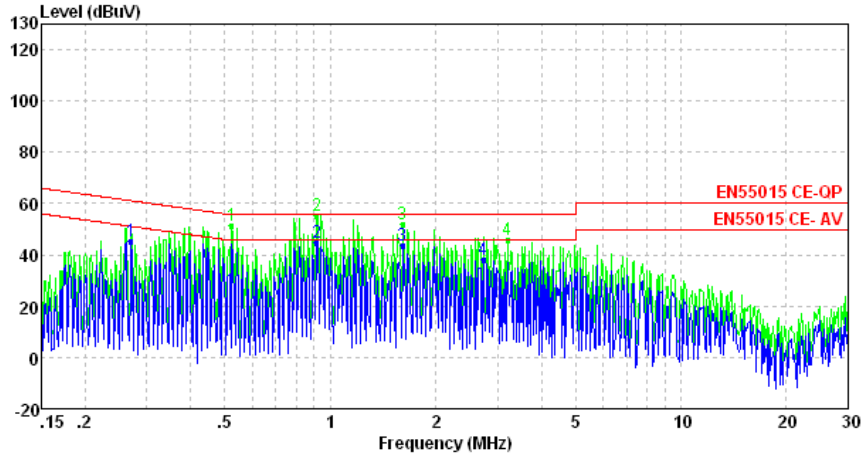

Site : Shenzhen BST Technology Co.,Ltd.

Condition:

: RBW:9.000KHz VBW:30.000KHz

	Freq	Level	Limit	Over	Remark	Pol/Phase
	MHz	dBuV	dBuV	dB		
1	0.27	45.22	51.12	-5.90	Average	LINE
2 Max	0.91	45.01	46.00	-0.99	Average	LINE
3	1.61	43.90	46.00	-2.10	Average	LINE
4	2.74	37.95	46.00	-8.05	Average	LINE

Site : Shenzhen BST Technology Co.,Ltd.

Condition:

: RBW:9.000KHz VBW:30.000KHz

	Freq	Level	Limit	Over	Remark	Pol/Phase
	MHz	dBuV	dBuV	dB		
1	0.52	51.13	56.00	-4.87	Peak	LINE
2 Max	0.91	55.46	56.00	-0.54	Peak	LINE
3	1.61	51.90	56.00	-4.10	Peak	LINE
4	3.21	45.63	56.00	-10.37	Peak	LINE

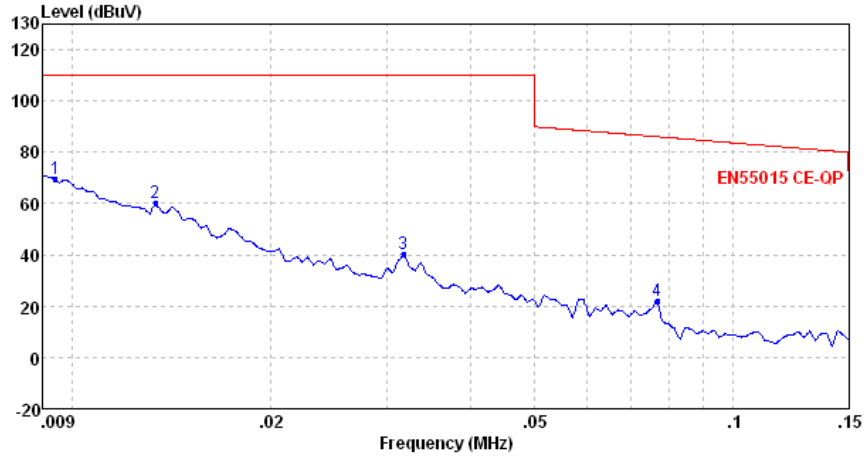

Site : Shenzhen BST Technology Co.,Ltd.

Condition:

: RBW:0.200KHz VBW:30.000KHz

	Freq	Level	Limit	Over	Remark	Pol/Phase
	MHz	dBuV	dBuV	dB		
1 Max	0.01	69.58	110.00	-40.42	Peak	NEUTRAL
2	0.01	60.36	110.00	-49.64	Peak	NEUTRAL
3	0.03	40.17	110.00	-69.83	Peak	NEUTRAL
4	0.08	22.30	86.09	-63.79	Peak	NEUTRAL

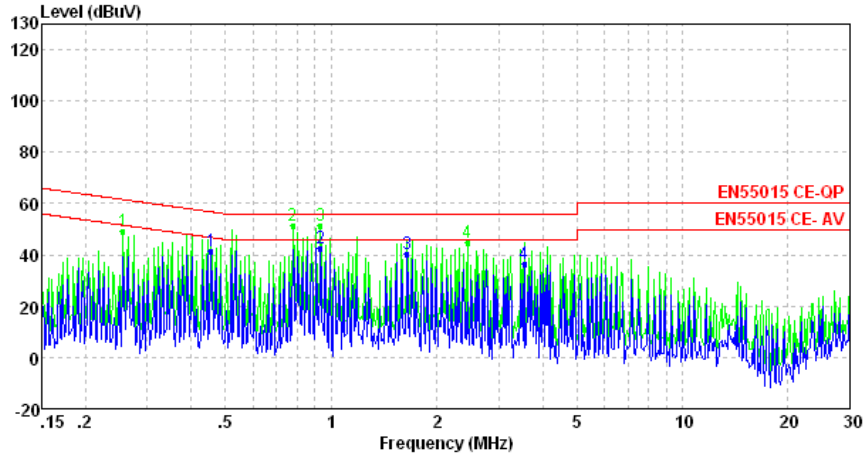

Site : Shenzhen BST Technology Co.,Ltd.

Condition:

: RBW:9.000KHz VBW:30.000KHz

	Freq	Level	Limit	Over	Remark	Pol/Phase
	MHz	dBuV	dBuV	dB		
1	0.46	41.44	46.76	-5.32	Average	NEUTRAL
2	0.93	42.62	46.00	-3.38	Average	NEUTRAL
3 Max	1.64	40.16	46.00	-5.84	Average	NEUTRAL
4	3.55	36.47	46.00	-9.53	Average	NEUTRAL

Site : Shenzhen BST Technology Co.,Ltd.

Condition:

: RBW:9.000KHz VBW:30.000KHz

	Freq	Level	Limit	Over	Remark	Pol/Phase
	MHz	dBuV	dBuV	dB		
1	0.26	49.06	61.56	-12.50	Peak	NEUTRAL
2	0.78	51.17	56.00	-4.83	Peak	NEUTRAL
3 Max	0.93	51.57	56.00	-4.43	Peak	NEUTRAL
4	2.45	44.76	56.00	-11.24	Peak	NEUTRAL



APPENDIX II

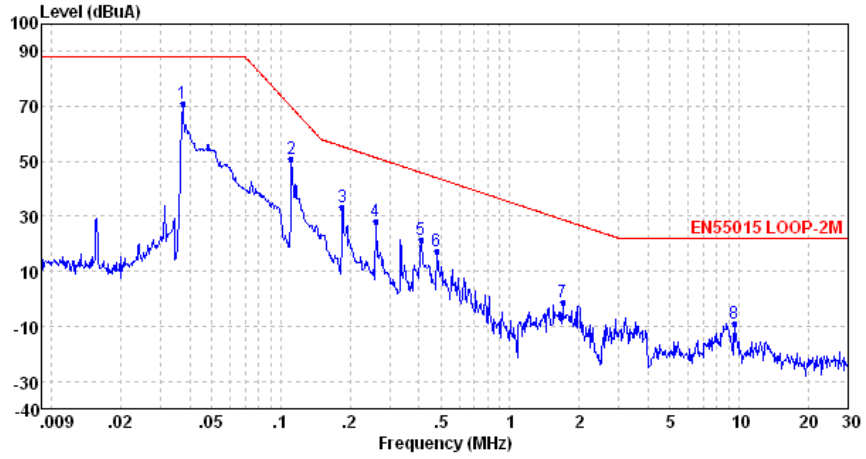

Site : Shenzhen BST Technology Co.,Ltd.

Condition:

: RBW:120.000KHz VBW:300.000KHz

Limit	Over
Line	Limit
Pol/Phase	
88.02	-17.01
69.78	-18.60
55.47	-21.98
51.47	-23.34
45.92	-24.28
44.06	-26.68
28.86	-30.35
22.02	-31.08

1	Max	0.04	71.01	88.02	-17.01
2		0.11	51.18	69.78	-18.60
3		0.19	33.49	55.47	-21.98
4		0.26	28.13	51.47	-23.34
5		0.41	21.64	45.92	-24.28
6		0.48	17.38	44.06	-26.68
7		1.70	-1.49	28.86	-30.35
8		9.56	-9.06	22.02	-31.08

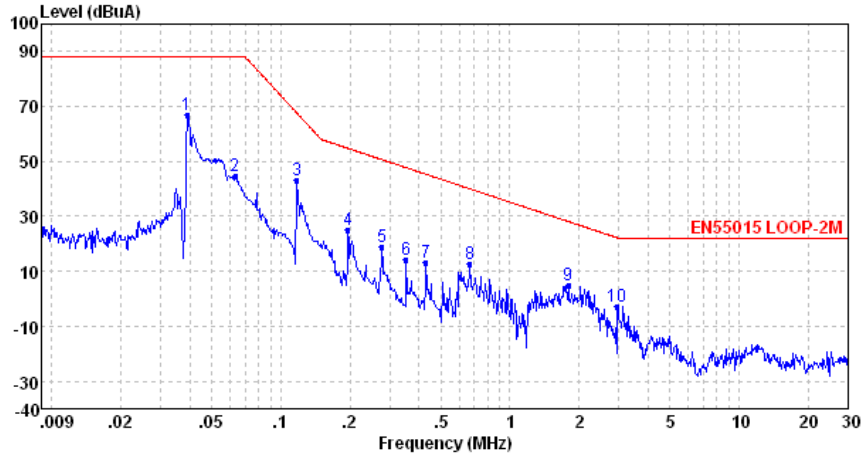

Site : Shenzhen BST Technology Co.,Ltd.
 Condition:

: RBW:120.000KHz VBW:300.000KHz

Freq	Level	Limit	Over	Pol/Phase
		Line	Limit	
MHz	dBuA	dBuA	dB	
1 Max	0.04	67.12	88.02	-20.90
2	0.06	44.49	88.02	-43.53
3	0.12	43.15	67.55	-24.40
4	0.20	25.23	54.79	-29.56
5	0.28	18.89	50.69	-31.80
6	0.35	14.05	47.77	-33.72
7	0.43	12.95	45.33	-32.38
8	0.67	12.60	40.07	-27.47
9	1.80	5.06	28.18	-23.12
10	2.95	-2.67	22.23	-24.90

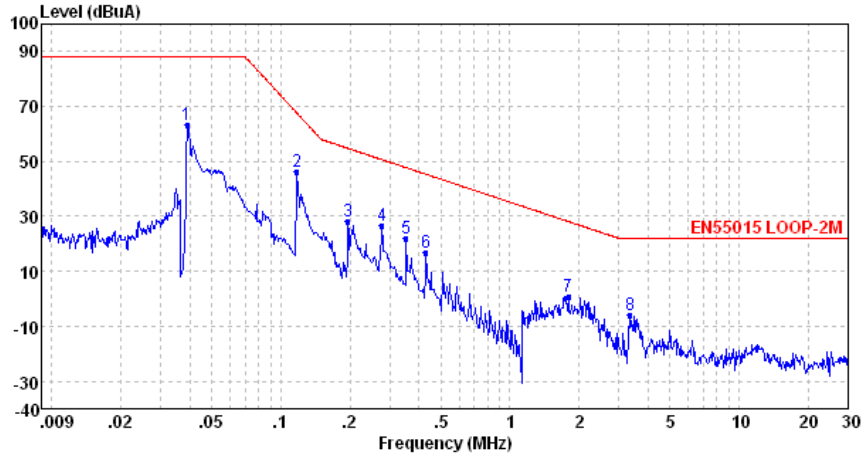

Site : Shenzhen BST Technology Co.,Ltd.

Condition:

: RBW:120.000KHz VBW:300.000KHz

Peak	Freq	Level	Limit	Over	Pol/Phase
	MHz	dBuA	dBuA	dB	
1	0.04	63.12	88.02	-24.90	
2 Max	0.12	46.15	67.55	-21.40	
3	0.20	28.23	54.79	-26.56	
4	0.28	26.89	50.69	-23.80	
5	0.35	22.05	47.77	-25.72	
6	0.43	16.95	45.33	-28.38	
7	1.80	1.06	28.18	-27.12	
8	3.36	-6.08	22.02	-28.10	



APPENDIX III

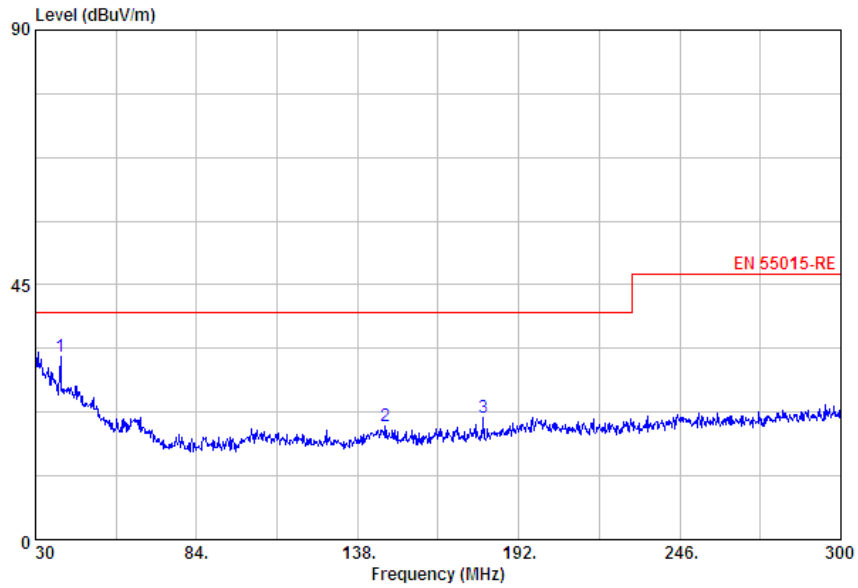

Condition : EN 55015-RE 3m HORIZONTAL
 : RBW:120.000KHz VBW:300.000KHz SWT:Auto

	Freq	Level	Limit	Over	Remark	Pol/Phase
	MHz	dBuV/m	dBuV/m	dB		
1 max	38.37	32.28	40.00	-7.72	Peak	HORIZONTAL
2	147.18	20.14	40.00	-19.86	Peak	HORIZONTAL
3	180.12	21.56	40.00	-18.44	Peak	HORIZONTAL

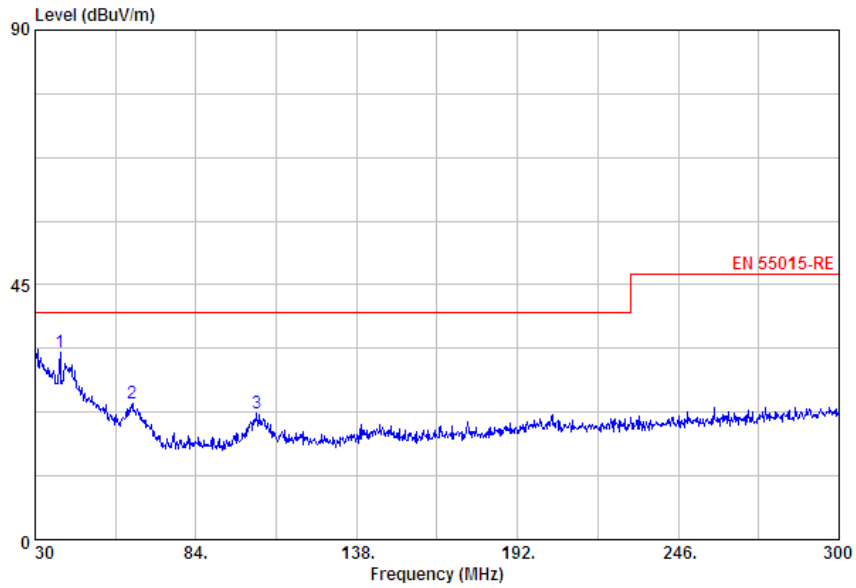

Condition : EN 55015-RE 3m VERTICAL
 : RBW:120.000KHz VBW:300.000KHz SWT:Auto

	Freq	Level	Limit	Over	Remark	Pol/Phase
	MHz	dBuV/m	dBuV/m	dB		
1 max	38.37	33.04	40.00	-6.96	Peak	VERTICAL
2	62.67	24.00	40.00	-16.00	Peak	VERTICAL
3	104.52	22.36	40.00	-17.64	Peak	VERTICAL



APPENDIX IV



Photo 1 General Appearance of the EUT

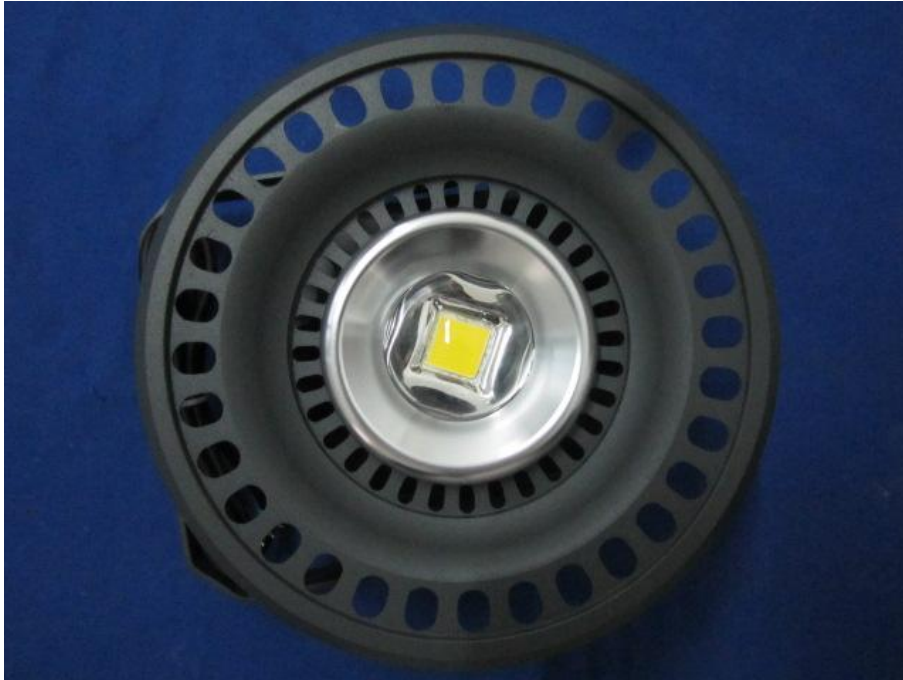

Photo 2 General Appearance of the EUT



Photo 3 General Appearance of the EUT



Photo 4 General Appearance of the EUT





Photo 5 Test scene



Photo 6 Test scene





Photo 7 Test scene

